

# Semi Frameless



## M2 Fix & Swing Bath Screen

### Installation Instructions

Semi Frameless  
Reversible



#### M2 Semi Frameless Fix & Swing Bath Screen

6mm clear safety glass  
Silver only  
Reversible to suit left or right entry  
500mm x 400mm (W) x 1450mm (H)  
I/N: 5137105

#### **IMPORTANT TO READ BEFORE INSTALLING**

Please inspect this product for damage, manufacturing fault or missing parts prior to commencing the process of installation, no warranty will be applied after installation has begun.

Prior to installation, please ensure there are no pipes or cables hidden in the wall where you intend to drill.

All of our Shower Screens must be handled with extreme care as glass is fragile and can shatter if handled incorrectly. Glass is not covered by warranty. You will notice through-out the installation process that the corners of any glass that is frameless or semi frameless have a protective cover. Please try to leave these protective covers on any panels that have them until after you have moved panels into position.

Throughout the entire installation process please ensure that the washers and grommets supplied are inserted correctly so that metal and glass do not make contact. Failure to do so will void warranty and may cause glass to break.

Flat packed DIY shower screens are heavy and may require two people to install.

Please refer to the supplied installation instructions to guide you through the installation process. Before you commence installation, refer to the Components List within the instructions along with the list of tools required to execute the installation.

We highly recommend that you cover the shower base area with a protective cloth through-out the installation process to avoid damage to your shower base.









## Components List



Wall Profile Part 1

Fixed Panel Part 2a

Swing Panel Part 2b

No.	Description
3	 Wall Plug
4	 ST4*30 Screws
5	 ST5*35 Screws
6	 ST*4x10 Screw
7	 Cover Caps
8	 Horizontal Water Seal
9a	 Swing Junction Block
9b	 Swing Junction Block
10	 Bracing Bracket

### Tools Required

- Level
- Drill
- Mallet
- Silicone
- Silicone gun
- Pencil
- Screw driver
- Tape measure
- Chisel
- Stanley Knife
- Drill bit 3.2mm & 6mm

**Step 1 Mark, Drill and Fix wall Profile**

- With a level, position **part 1 wall profile** against the wall on top of bath at desired measurement. 5 - 10mm in from the edge of bath or Inside of lip of bath.
- With a pencil, mark the pre drilled holes inside of **Part 1 wall profile**.
- Remove wall profile and drill 6mm hole. (Use a masonry drill bit if drilling into tiles).
- Insert **Part 3 Wall plugs**.
- Using **Part 4 ST4\*30 Screw** provided, fix **Part 1 wall Profile** to wall ensuring wall profile is level and fixed tightly to wall.

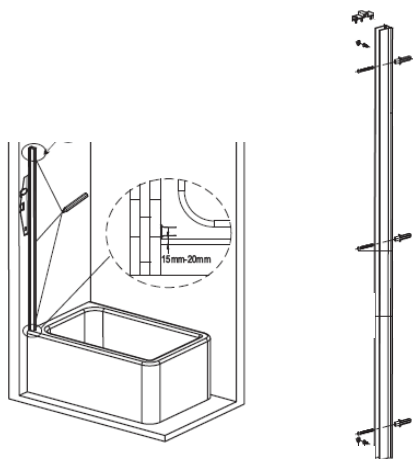
**Step 2 Assembly of Fixed Panel**

- Figure out which way **Part 2a Fixed Panel** will attach to wall and turn **Part 2a Fixed Panel** upside down.
- Fix **Part 9a Swing Junction Block** to the leading edge of **Part 2a Fixed panel** using **Part 4 St\*4x30 Screw** and ensure its fixed tightly.
- Turn **Part 2a Fixed Panel** up the right way and insert **Part 2b swing Panel** on to the **Part 9a Swing Junction Block**.
- Place the second **Part 9b Swing Junction Block** to the top of swing panel connecting both panels together.
- Fix **Part 9b Swing Junction Block** to the leading edge of **Part 2 a Fixed panel** using **Part 4 St\*4x30 screws** and ensure its fixed tightly.

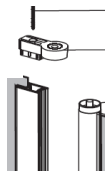

**Step 3 Insert Bath Panel and Fix off**

- a) Place the **Part 2a Fixed panel** in to **Part 3 wall Profile** and ensure door is operating correctly. Adjust if necessary.
- b) Fix internally by drilling 3 equally spaced 3.3mm holes through both wall profile and extrusion attached to fixed panel and secure Using **Part 6 St\*4x10 Screw** provided.

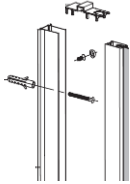
**Step 4 Attaching Bracing Bracket**

- a) Place **Part 10 Bracing Bracket** on the top of the fixed panel and slide bracket in to position so arm meets internal wall.
- c) With a pencil mark the area where the bracket meets the wall.
- d) Remove **Part 14 Bracing Bracket** and drill 6mm hole. (Use a masonry drill bit if drilling into tiles).
- e) Insert **Part 3 Wall Plug**.
- f) Place **Part 10 Bracing Bracket** back in to position on top of fixed panel and fix to wall tightly using **Part 5 St4\*35**.

**Please Ensure plastic washers are inserted correctly avoiding glass and metal making contact. Failure to do so will void warranty and may cause glass to break.**

- g) Tighten the screw on **Part 10 Bracing Bracket** fixing tightly to Fixed Panel.
- h) With thumb pressure press on **Part 7 Cover Caps** on to screw heads.
- i) With Hand Pressure attach **Part 8 Horizontal water seal** to bottom of **Part 2b Swing Panel**. Ensure that the flap is facing internal of screen.

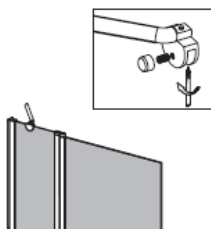
**Step 5 Sealing**

- a) Using recommended bathroom purpose silicone. Apply a fine bead of silicone vertically and horizontally on the outside perimeter of screen only, sealing your shower screen. Only seal around the fixed. This will prevent water from leaking out of screen and will allow water to effectively drain back towards outlet. Do not use shower for 24 hours allowing for silicone to set.

Trading as Rick McLean's Designer Bathware

#### WARRANTY

##### - Measured & Installed Products

Rick McLean's Designer Bathware will provide a 2 year Service Warranty on installation and componentry of measured & fitted Shower Screens, Mirrors & Sliding Robe Doors. Cracked, smashed or broken Glass, Splashbacks and Mirrors are NOT included. Warranty does not cover glass. Replacement glass is covered by the customer's house & contents insurance policy (if applicable) or at the customer's own expense.

##### - Supply Only Products

Rick McLean's Designer Bathware will supply a replacement product where faulty manufacture or faulty materials exists, only in accordance with correct installation procedure.

This warranty DOES NOT apply to other defects which may have arisen as a result of; accidental damage, misuse, abuse, maltreatment, wear & tear, incomplete return, abnormal stress or neglect of any kind.

This warranty DOES NOT include REMOVAL AND/OR INSTALLATION COSTS and any other associated expenses incurred, including those costs incurred from third party.

It is the responsibility of the recipient to inspect the product/s once received to ensure no transit damage has occurred, and/or missing parts or manufacturing faults are applicable.

Plumbing and Bathware products must be installed by a licensed plumber. Failure to do so will immediately void warranty.

Failure due to other causes, including the use of other than recommended installation procedures, may also void warranty.

Please ensure that plumbing and bathware products are installed in accordance with local by-laws.

Please ensure glass and fragile products are handled with care. Avoid knocks & shock to all sides of packaging when transporting.

Freestanding Baths are not designed to be installed hard up against bathroom walls. The sides of the baths taper, even if they appear to be straight edged. Installing freestanding baths up against tiled walls or recessing baths into walls and tiling down onto them is at the client's own discretion. This is not in accordance with correct installation procedure and will void warranty.

Sizes, Prices and Stock Availability of products are subject to change without notice.

#### Warranty does not cover glass.

Broken Glass or missing parts will not be replaced under warranty if the Shower Screen is in the process of being installed.

The safety glass featured in all Shower Screens cannot be cut, trimmed or altered in any way.

Manufactured sizes of Shower Screens, Shower Bases & Baths are nominal. Actual sizes may vary during manufacturing.

##### - How to make a claim for Credit or Exchange of Goods for Supply Only Products

Rick McLean's Designer Bathware will credit or exchange goods within 14 working days from time of purchase.

The customer will be deemed to have accepted the goods as being in accordance with its order unless it notifies Rick McLean's Designer Bathware of its claim within 14 days of receipt of the goods.

All returned goods will incur a 25% restocking fee on the total cost of goods.

The following conditions must be met however in order to accept returned goods:

- We have received prior notification by advising our office on 03 9331 6660 or in person
- Original tax invoice must be supplied
- Goods must still be in original condition
- Goods must still be in original packaging
- Customer is responsible for arranging return of goods and all transportation costs involved
- In the circumstance that a credit is issued, we will hold a credit for 30 days

Any goods authorised for return shall be returned at the customer's expense.